

Steel  
Systems  
Installation<sup>INC.</sup>

# PRODUCT LINES & PROJECT PHOTOS

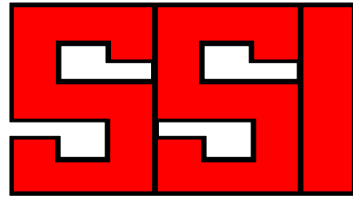

**Steel  
Systems  
Installation<sup>INC</sup>**

## **Custom Processing Plant Construction**

Steel Systems Installation, Inc. (SSI) is a full-service, aggregate processing system engineering and consulting firm, recognized as a leader in the aggregate industry. We are among the top aggregate processing systems design and engineering providers in the Mid-Atlantic, and we have a long history of providing exceptional service for our clients. Our success lies in our technical expertise, responsive staff and longstanding relationships. Our work ethic, attention to detail, and drive for excellence keep our customers coming back.

- Aggregate/Mineral Crushing Plants
- Sand Processing Plants
- Bulk Material Handling Facilities
- Industrial Minerals Processing Systems
- Railcar and Barge Loading/Unloading Facilities
- Turnkey Processing Plants



**Serving the Aggregate Industry for over 25 Years**

Steel Systems Installation, Inc. • P.O. Box 307 • 175 North Lime Street • Quarryville, PA 17566  
Phone (717) 786-1264 • Fax (717) 786-2763 • [www.steelssystems.com](http://www.steelssystems.com)

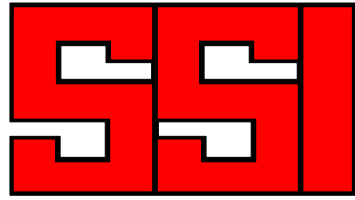

**Steel  
Systems  
Installation<sup>INC</sup>**

## **Barge and Ship Unloading Systems**

- Barge and Ship Loading & Unloading Systems require specialized equipment that can operate in a variety of conditions.
- Design and Engineering experience is very important in these critical applications.
- Equipment and Structures are often subject to adverse elements such as salts, winds and constant high humidity which may require specialized coatings.

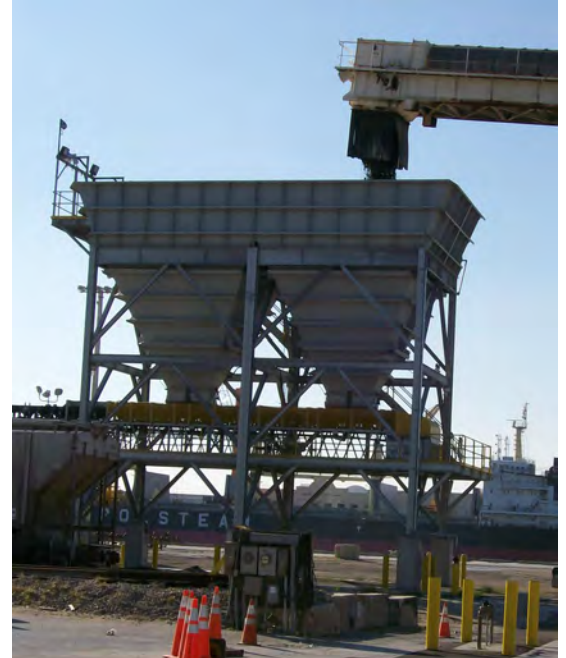

**Serving the Aggregate Industry for over 25 Years**

Steel Systems Installation, Inc. • P.O. Box 307 • 175 North Lime Street • Quarryville, PA 17566  
Phone (717) 786-1264 • Fax (717) 786-2763 • [www.steelssystems.com](http://www.steelssystems.com)

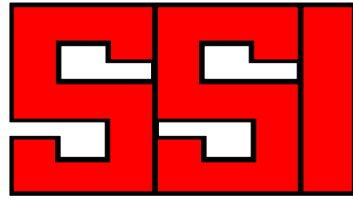

**Steel  
Systems  
Installation<sup>INC</sup>**

## **Railcar Loading & Unloading**

- Railcar Unloading Stations Designed to Suit Your Needs.
- Loading/Unloading Rates as high as 2,500TPH.
- Conveying Configurations to maximize stockpiles or storage space.
- Loading Bins and Conveyors with Belt Scales or Load Cells.
- Car Shakers, Retractable Belt Feeders and Dust Collection/Suppression Systems.



**Serving the Aggregate Industry for over 25 Years**

Steel Systems Installation, Inc. • P.O. Box 307 • 175 North Lime Street • Quarryville, PA 17566  
Phone (717) 786-1264 • Fax (717) 786-2763 • [www.steelssystems.com](http://www.steelssystems.com)

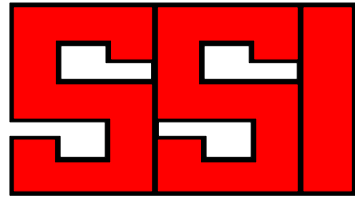

**Steel  
Systems  
Installation<sup>INC</sup>**

## **Primary Crusher Stations**

- Primary Crushing Stations for any capacity facility or any type of primary crusher.
- Control Building Support Structures.
- Rock Breaker Support Structures.
- Enclosed or Open Primary Dumping Stations.
- Retaining Wall Engineering and Design.
- Field Service and Installation.



**Serving the Aggregate Industry for over 25 Years**

Steel Systems Installation, Inc. • P.O. Box 307 • 175 North Lime Street • Quarryville, PA 17566  
Phone (717) 786-1264 • Fax (717) 786-2763 • [www.steelssystems.com](http://www.steelssystems.com)

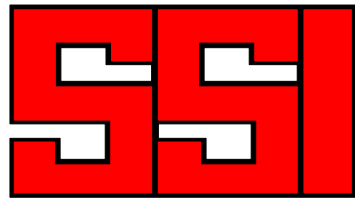

**Steel  
Systems  
Installation<sup>INC</sup>**

## **Secondary/Tertiary Crushing Stations**

- Secondary & Tertiary Crushing Stations for any capacity facility or any type of crusher.
- Enclosed or Open Crushing Stations.
- Optional Surge Bins & Feeder Arrangements
- User Friendly Crusher Maintenance Design
- Field Service and Installation.



**Serving the Aggregate Industry for over 25 Years**

Steel Systems Installation, Inc. • P.O. Box 307 • 175 North Lime Street • Quarryville, PA 17566  
Phone (717) 786-1264 • Fax (717) 786-2763 • [www.steelssystems.com](http://www.steelssystems.com)

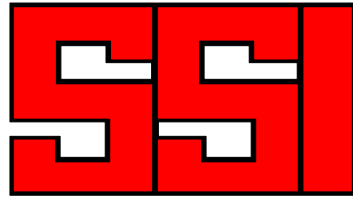

**Steel  
Systems  
Installation<sup>INC</sup>**

## **Screen Towers**

- Screen Towers and Support Structures
- Designed to Support any Size or Type of Screen.
- Enclosed, Semi Enclosed or Open Structure Type.
- Wear Minimizing “Quiet” Design.
- Blending and Roll-Away Chutes.
- Dust Containment.
- Full Access Around Equipment.
- Turnkey Installation Services.



**Serving the Aggregate Industry for over 25 Years**

Steel Systems Installation, Inc. • P.O. Box 307 • 175 North Lime Street • Quarryville, PA 17566  
Phone (717) 786-1264 • Fax (717) 786-2763 • [www.steelssystems.com](http://www.steelssystems.com)

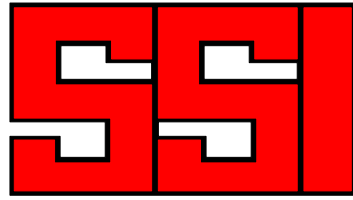

**Steel  
Systems  
Installation<sup>INC</sup>**

## **Custom Designed Stationary Conveyors**

- Custom Designed Conveyors to Maximize Production in your Existing Plant.
- Plant Conveyor Systems Design & Engineering.
- Belt Widths from 18" to 54".
- Drives from 5HP to 500HP.
- Domestic or Imported Drive and Bearing Components.
- Surge Pile and Tunnel Reclaim Conveyors.
- Fully Guarded to MSHA and OSHA Specifications.
- Field Installation Services.



**Serving the Aggregate Industry for over 25 Years**

Steel Systems Installation, Inc. • P.O. Box 307 • 175 North Lime Street • Quarryville, PA 17566  
Phone (717) 786-1264 • Fax (717) 786-2763 • [www.steelssystems.com](http://www.steelssystems.com)



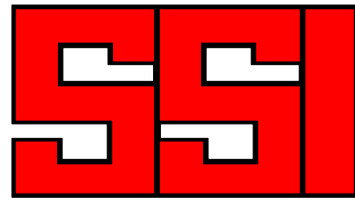

**Steel  
Systems  
Installation<sup>INC</sup>**

## **Radial Stacking Conveyors**

- Available in all lengths and widths up to 54”.
- Options include:
  - Walkway
  - Belt Covers
  - Cross-over Platforms for Drive Access
  - Safety Stop Switch Protection
  - Belt Run-off Switches
  - Domestic or Import Components
  - Primary/Secondary Belt Scrapers
- Fully Guarded to meet MSHA and OSHA specifications.



**Serving the Aggregate Industry for over 25 Years**

Steel Systems Installation, Inc. • P.O. Box 307 • 175 North Lime Street • Quarryville, PA 17566  
Phone (717) 786-1264 • Fax (717) 786-2763 • [www.steelssystems.com](http://www.steelssystems.com)

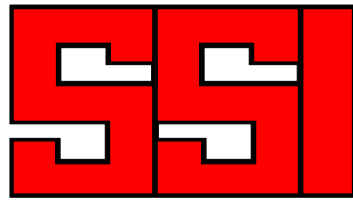

**Steel  
Systems  
Installation<sup>INC</sup>**

## **Hoppers & Bins**

- Concrete Plant Feed Hoppers
- Dump Hoppers for Crushing Plants
- Reclaim Hoppers
- Truck load-Out Bins
- Weighing & Blending Bins
- Crusher Surge Bins

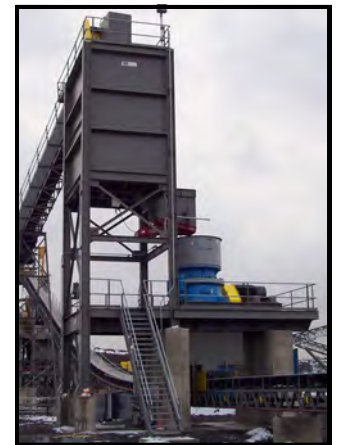

**Serving the Aggregate Industry for over 25 Years**

Steel Systems Installation, Inc. • P.O. Box 307 • 175 North Lime Street • Quarryville, PA 17566  
Phone (717) 786-1264 • Fax (717) 786-2763 • [www.steelssystems.com](http://www.steelssystems.com)

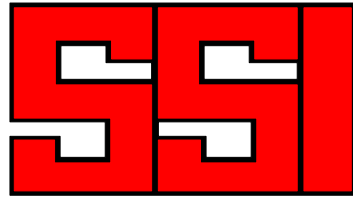

**Steel  
Systems  
Installation<sup>INC</sup>**

## **Engineering Services**

- Design/Build and Construction Management Services.
- Equipment Application.
- Plant Flow Analysis.
- Latest in CAD and 3D Modeling Design.
- Field Measuring and Site Surveys.
- Circuit Optimization.

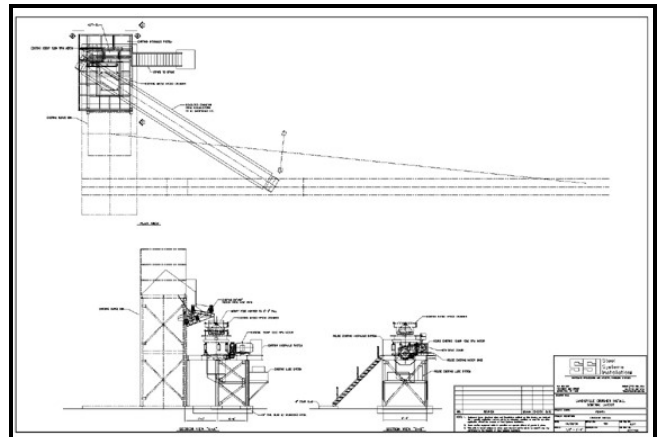
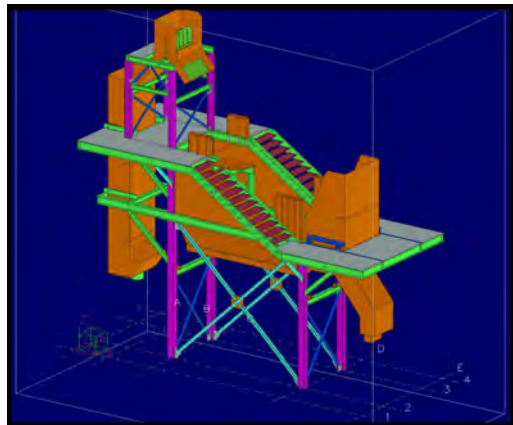
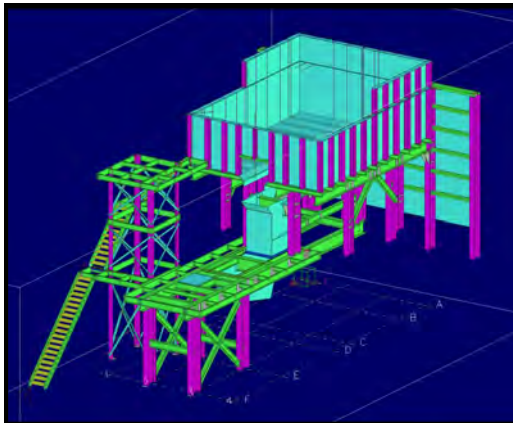
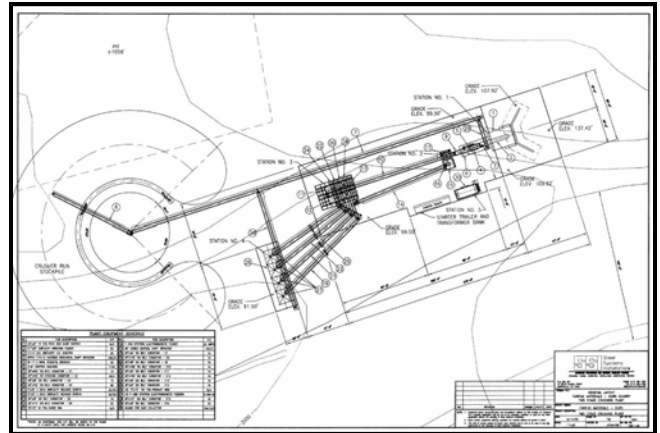

**Serving the Aggregate Industry for over 25 Years**

Steel Systems Installation, Inc. • P.O. Box 307 • 175 North Lime Street • Quarryville, PA 17566  
Phone (717) 786-1264 • Fax (717) 786-2763 • [www.steelssystems.com](http://www.steelssystems.com)

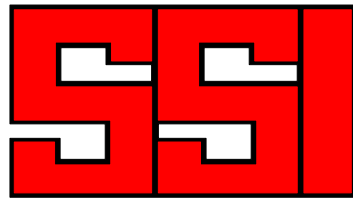

**Steel  
Systems  
Installation<sup>INC</sup>**

## **Fabrication**



**AGGREGATE BINS & HOPPERS**



**CONVEYOR DRIVE & TAIL TERMINALS**



**PORTABLE/SKID MOUNTED PLANTS**



**SPECIALTY MAUNFACTURING**



**STRUCTURAL PLATE FABRICATION**



**CAD INTEGRATED PLASMA TABLE**



**HOT/COLD STORAGE TANKS**

**Serving the Aggregate Industry for over 25 Years**

Steel Systems Installation, Inc. • P.O. Box 307 • 175 North Lime Street • Quarryville, PA 17566  
Phone (717) 786-1264 • Fax (717) 786-2763 • [www.steelssystems.com](http://www.steelssystems.com)

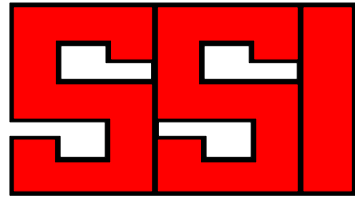

**Steel  
Systems  
Installation<sup>INC</sup>**

## **Field Erection & Installation Services**



**Serving the Aggregate Industry for over 25 Years**

Steel Systems Installation, Inc. • P.O. Box 307 • 175 North Lime Street • Quarryville, PA 17566  
Phone (717) 786-1264 • Fax (717) 786-2763 • [www.steelssystems.com](http://www.steelssystems.com)

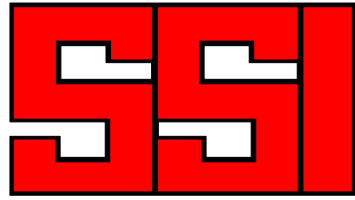

**Steel  
Systems  
Installation<sup>INC</sup>**

## **Dust Collection/Supression Systems**



**Serving the Aggregate Industry for over 25 Years**

Steel Systems Installation, Inc. • P.O. Box 307 • 175 North Lime Street • Quarryville, PA 17566  
Phone (717) 786-1264 • Fax (717) 786-2763 • [www.steelssystems.com](http://www.steelssystems.com)

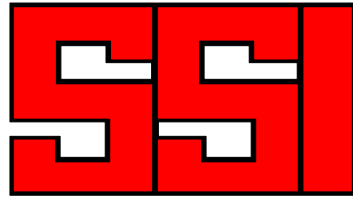

**Steel  
Systems  
Installation<sup>INC</sup>**

## **Fines Recovery Systems**

- Recover Fines Larger Than 500 Mesh.
- Recovered Product has Less Than 25% Moisture. Can be Sold for Fillers, Ag-lime or Blended into Base Materials.
- Krebs G-Max Cyclones are Very Efficient, Durable and Have Fewer Connections and Fittings Than Units With Numerous Small Cyclones.
- Sisetec Screens Provide High G-Force Dewatering Action. Decked With Urethane Screening Surfaces
- Screens are Available in Sizes From 3'x10' Through 6'x10' to Suit Individual Needs.
- Fines Recovery Systems are Self Contained with Constant Level Sumps.



**Serving the Aggregate Industry for over 25 Years**

Steel Systems Installation, Inc. • P.O. Box 307 • 175 North Lime Street • Quarryville, PA 17566  
Phone (717) 786-1264 • Fax (717) 786-2763 • [www.steelssystem.com](http://www.steelssystem.com)

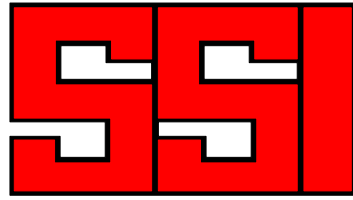

**Steel  
Systems  
Installation<sup>INC</sup>**

## **Asphalt Cold Feed Systems**

- Custom Engineered Cold Feed Systems
- Multiple or Single Bin Configurations
- Belt Feeders or Vibrating Feeders
- Variable and Proportionate Controls
- Optional Grizzly Bars
- Field Installation and Service



**Serving the Aggregate Industry for over 25 Years**

Steel Systems Installation, Inc. • P.O. Box 307 • 175 North Lime Street • Quarryville, PA 17566  
Phone (717) 786-1264 • Fax (717) 786-2763 • [www.steelssystems.com](http://www.steelssystems.com)



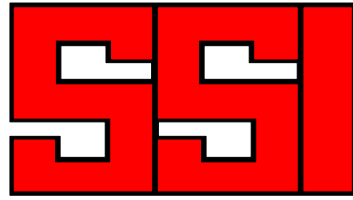

**Steel  
Systems  
Installation<sup>INC</sup>**

## Silos

- Standard Line of Silos Ranging from 350 Barrel to 1050 Barrel Capacities.
- Custom Sizes and Split Silos.
- Full Line of Accessories Available:
  - Dust Collectors
  - Relief Valves
  - Level Detection
  - Access Platforms
  - Screw Conveyors
  - Flow Devices
- Supports can be Custom Designed to Suit Existing Batchers and Truck Load-Out Systems.
- Field installation Services.



**Serving the Aggregate Industry for over 25 Years**

Steel Systems Installation, Inc. • P.O. Box 307 • 175 North Lime Street • Quarryville, PA 17566  
Phone (717) 786-1264 • Fax (717) 786-2763 • [www.steelssystem.com](http://www.steelssystem.com)

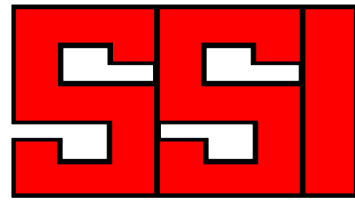

**Steel  
Systems  
Installation<sup>INC</sup>**

## **Clam Gates**

### **STANDARD FEATURES INCLUDE:**

- Box fabricated from 3/8" plate.
- Gears cut from 3/4" plate.
- 3" flange punched to user specification.
- Oil impregnated bronze bushing.
- Quantity discounts available.

### **Standard Sizes available:**

12" x 12"	12" x 14"	12" x 18"	14" x 14"
15" x 15"	16" x 16"	18" x 18"	20" x 20"
24" x 24"			

*Other sizes available upon request.*



**Serving the Aggregate Industry for over 25 Years**

Steel Systems Installation, Inc. • P.O. Box 307 • 175 North Lime Street • Quarryville, PA 17566  
Phone (717) 786-1264 • Fax (717) 786-2763 • [www.steelssystems.com](http://www.steelssystems.com)

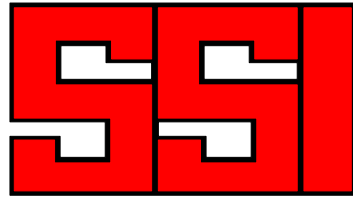

**Steel  
Systems  
Installation<sup>INC</sup>**

## **Block Tumbler**

- 5ft dia. x 20ft long barrel with internal flights to tumble the block
- Adjustable decline to control the time in tumbler
- Sound deadening insulation
- Aluminum skin for weather protection
- Heavy duty chain drive
- 20hp AC variable speed drive to control tumbling action
- Dust collector with 5hp, 2,200CFM fan
- Steel support structure with access stairs and platform on feed end
- Electrical control panel



**Serving the Aggregate Industry for over 25 Years**

Steel Systems Installation, Inc. • P.O. Box 307 • 175 North Lime Street • Quarryville, PA 17566  
Phone (717) 786-1264 • Fax (717) 786-2763 • [www.steelssystems.com](http://www.steelssystems.com)

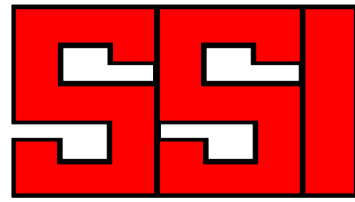

**Steel  
Systems  
Installation<sup>INC</sup>**

## Pugmills

- Custom Designed Pugmills and Pugmill Stations.
- Portable or Static Models.
- Capacities from 100 TPH to 1,000 TPH.
- Independent Shaft Drives.
- Integrated Controls for Blending & Mixing.
- Supports can be Custom Designed to Suit Existing Batchers and Truck Load-Out Systems.
- Field installation Services.



**Serving the Aggregate Industry for over 25 Years**

Steel Systems Installation, Inc. • P.O. Box 307 • 175 North Lime Street • Quarryville, PA 17566  
Phone (717) 786-1264 • Fax (717) 786-2763 • [www.steelssystems.com](http://www.steelssystems.com)

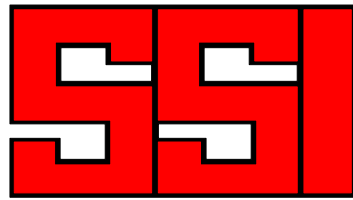

**Steel  
Systems  
Installation<sup>INC</sup>**

**Belt Scales \* Weighbelt Feeders \* Sampling**



**N-61 Scale System**

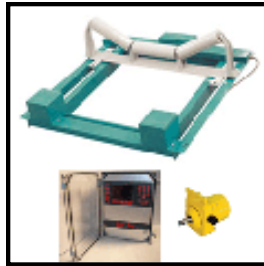

**N-62 Scale System**



**N-64 Scale System**

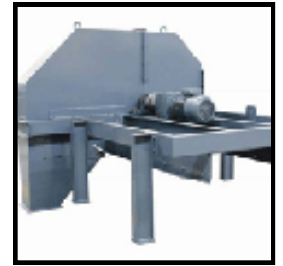

**Sweep Sampler System**



**Single Idler Weigh Bridge**



**BPS Digital Integrator**

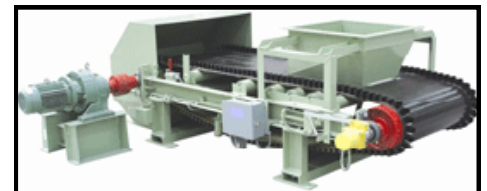

**Volumetric Feeder Model F-54**



**Weighbelt Feeder Model F-51**



**Weighbelt Feeder Model F-52**



**Weighbelt Feeder Model F-53**

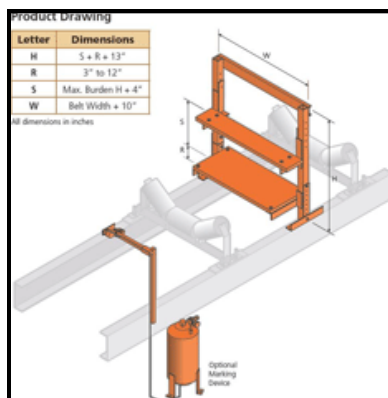

**Tramp Metal Detector Model 50**

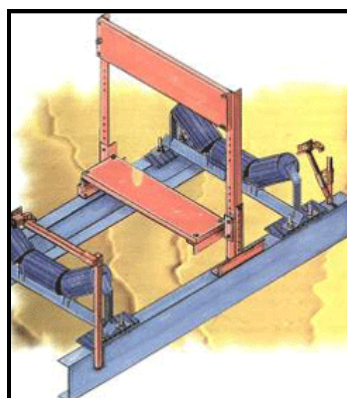

**Tramp Metal Detector Model 100**

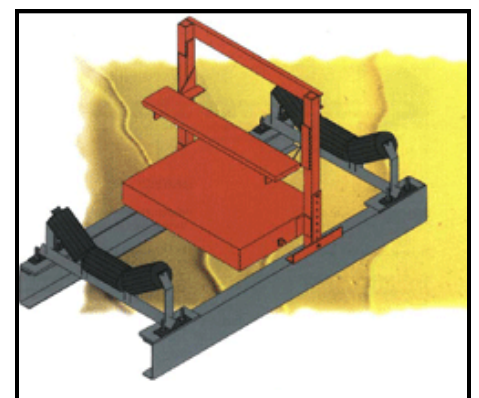

**Tramp Metal Detector Model 5500**

**Serving the Aggregate Industry for over 25 Years**

Steel Systems Installation, Inc. • P.O. Box 307 • 175 North Lime Street • Quarryville, PA 17566  
Phone (717) 786-1264 • Fax (717) 786-2763 • [www.steelssystems.com](http://www.steelssystems.com)

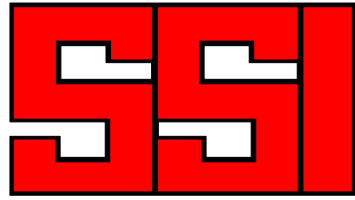

**Steel  
Systems  
Installation<sup>INC</sup>**

## Level Detection & Conveyor Switches



Tuning Fork Level Switch



Paddle Level Switch



Capacitive Level Switch



Diaphragm Level Switch



Belt Rip Protection Switch



Tilt Switch w/Optional Control



Tripper Position Switch



Under Speed Switch



Belt Run-Off Switch



Magnetic Speed Switch



Safety Stop Pull Cord Switch

**Serving the Aggregate Industry for over 25 Years**

Steel Systems Installation, Inc. • P.O. Box 307 • 175 North Lime Street • Quarryville, PA 17566  
Phone (717) 786-1264 • Fax (717) 786-2763 • [www.steelssystems.com](http://www.steelssystems.com)

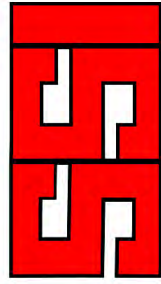

## Steel Systems Installation<sup>®</sup>

### FIXED HEIGHT TELESCOPING STACKERS

Some applications call for sophisticated, high dollar solutions; others call for a straight-forward, basic, workmanlike solution. While our competitors continue to try and outdo each other by adding more and more bells and whistles, we are proud to introduce a down to earth alternative for your stockpiling needs.

Steel Systems Installation, Inc. (SSI) fixed height telescoping stackers offer the basic functionality of similar stackers but at a greatly reduced price. We manufacturer our telescoping stackers with an emphasis on:

- **Safety :** Minimal moving parts  
Guarded to local MSHA regulations
- **Durability:** Quarry-duty construction  
Proven, reliable components
- **Performance:** Capacities up to 1,200 TPH  
Efficient stockpiling
- **Simplicity:** No hydraulics  
User friendly operational interface  
Standard off-the-shelf components  
Extensive practical design experience

SSI telescoping stackers are available in belt widths up to 48" and capacities up to 1,200 TPH. Basic functions include power travel and telescoping extension up to 150' in length.

Optional features include walkway access to all drives and the winch mechanism, maintenance platforms, automation packages, idler and belting options **ALL** at a price you can justify!

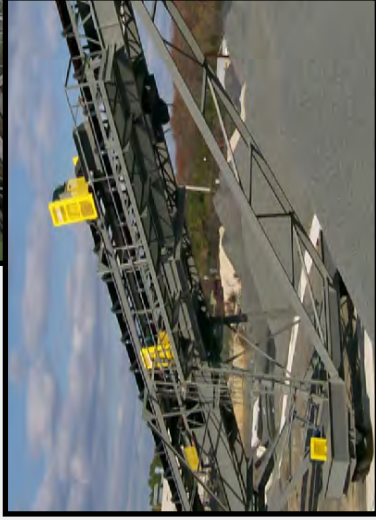
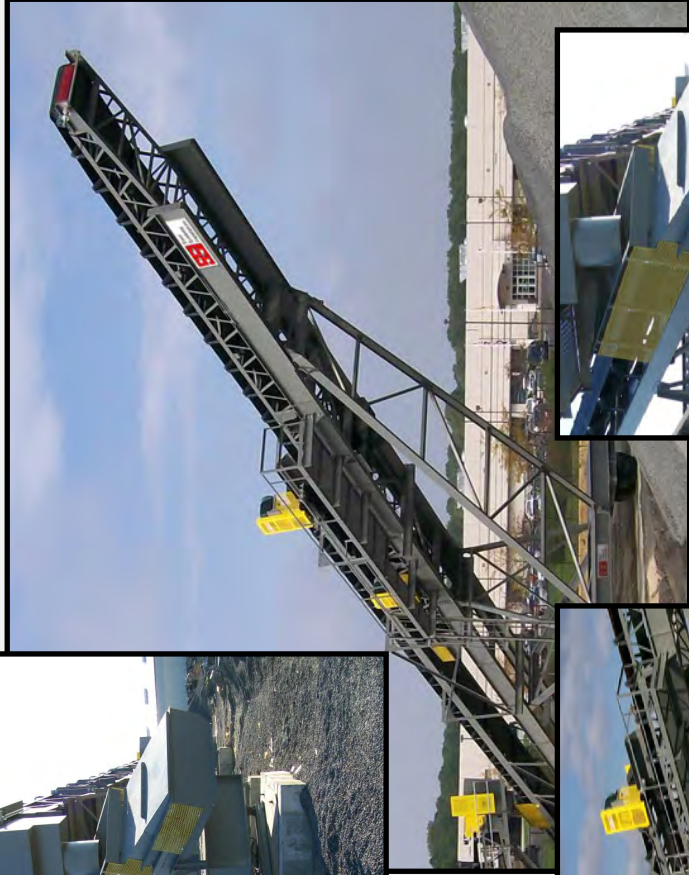
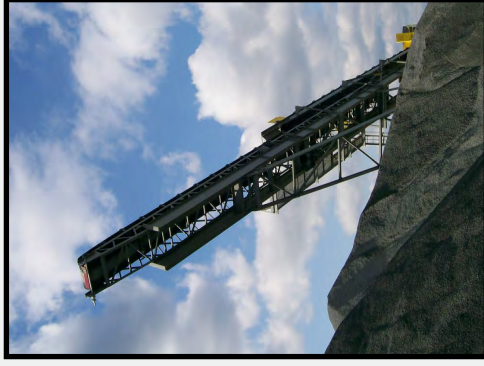

**WHY PAY FOR FEATURES YOU DON'T NEED OR USE?**